

Alcatel-Lucent **OmniPCX** Office



Alcatel-Lucent IP Touch 4068 Phone
Alcatel-Lucent IP Touch 4038 Phone
Alcatel-Lucent 4039 Digital Phone

Introduction

Thank you for choosing a telephone from the IP Touch 4038 Phone/4039 Digital Phone/IP Touch 4068 Phone range manufactured by **Alcatel-Lucent**.



Your terminal has a new ergonomic layout for more effective communication.

- A large graphic screen, in conjunction with various keys and the navigator, allows you to make calls, configure and program your telephone.
- a receiver that is pleasant to use: it fits nicely in the hand with a flexible grip section,
- communication is even more convenient using the audio keys (loudspeaker, hands free),
- using the convenient alphabetic keypad, you can call your correspondents by name.





How to use this guide



• Actions

-  Lift the receiver.
-  Hang up.

• Keypad

-  Numeric keypad.
-  Alphabetic keypad.
-  Specific key on numeric keypad.



• Navigator

-  Move the navigation key up, down, to the left or to the right.
-  To go back one level (press and release) or to return to the welcome page (press and hold) ; during a conversation, can be used to access the different pages (Menu, Perso, etc.) and to return to the telephone screens.



• Display and display keys

-  Partial view of display.
-  Display key.



• Audio keys

-  Loudspeaker, hands free.
-  Adjustment "reduce".
-  Adjustment "increase".





• Programmable keys and icons

-  Line key.
-  Icon corresponding to key.

• Other fixed keys

-  Fixed key.
-  MENU key.
-  Voice mail access key.

• Other symbols used

-  Means that the function is accessible from the Menu page.
-  Means that the function is accessible from the Perso page.
-  Means that the function is accessible from the Info page.
-  Means that the function is subject to programming. If necessary, contact your installer.

These symbols can be supplemented by small icons or text.

Contents

Getting to know your telephone p.6

1.

Description of the screens and Bluetooth® handset p.7

- 1.1 Welcome screens p.7
- 1.2 Call management screen p.8
- 1.3 Application screen p.8
- 1.4 IP Touch Bluetooth® Wireless handset p.9

2.

Using your telephone p.10

- 2.1 Making a call p.10
- 2.2 Receiving a call p.10
- 2.3 Using the telephone in "Hands free" mode p.10
- 2.4 Activating the loudspeaker during a conversation (receiver lifted) p.11
- 2.5 Calling your correspondent by name (company directory) p.11
- 2.6 Make calls via your programmed call keys p.11
- 2.7 Calling from the common directory p.11
- 2.8 Filtering calls using the voice mailbox p.11
- 2.9 Redialling p.12
- 2.10 Requesting automatic callback if internal number is busy p.12
- 2.11 Answering an internal call in intercom mode p.12
- 2.12 Sending DTMF signals p.12
- 2.13 Mute, so that your correspondent cannot hear you p.13

3.

During a conversation p.14

- 3.1 Making a second call during a conversation p.14
- 3.2 Answering a second call during a conversation p.14
- 3.3 Switching between calls (Broker call) p.14
- 3.4 Transferring a call p.15
- 3.5 Transfer a call to the voice mailbox of an absent party p.15
- 3.6 Three-way conference with internal and/or external correspondents (conference) p.15
- 3.7 Placing a call on hold (hold) p.15
- 3.8 Placing an outside call on hold (parking) p.16
- 3.9 Intrusion into an internal conversation p.16
- 3.10 Store a number p.16
- 3.11 Adjust audio volume p.16

4.

'Meet me' conference p.17

- 4.1 Initiate a 'Meet me' conference p.17
- 4.2 Join a 'Meet me' conference p.17

5.

Sharing p.18

- 5.1 Receiving supervised call ringing p.18
- 5.2 Answering the general bell p.18
- 5.3 Manager/secretary filtering p.18
- 5.4 Call pick-up p.18
- 5.5 Answering briefly in place of the operator p.18
- 5.6 Hunting groups p.19
- 5.7 Calling an internal correspondent on his/her pager p.19
- 5.8 Answering a call on your pager p.19
- 5.9 Calling a correspondent on his/her loudspeaker p.19
- 5.10 Sending a written message to an internal correspondent p.19
- 5.11 Send a voice message copy p.20
- 5.12 Sending a recorded message to a number / a distribution list p.20
- 5.13 Broadcasting a message on the loudspeakers of a station group p.21
- 5.14 Modify the automated attendant welcome message remotely p.21

6.

Keep in touch p.22

- 6.1 Selecting calls to be diverted p.22
- 6.2 Diverting calls to another number (immediate diversion) p.22
- 6.3 Diverting your calls to your voice message service p.22
- 6.4 When you return, consult recorded messages p.22
- 6.5 Activate/disable the personal assistant p.22
- 6.6 Personal assistant : reaching you with one number only p.23
- 6.7 Diverting calls to your pager p.23
- 6.8 Forwarding your calls from the receiving terminal ("Follow me") p.23
- 6.9 Applying a selective diversion p.23
- 6.10 Diverting all group calls p.23
- 6.11 Cancelling all diversions p.23
- 6.12 Cancelling a specific diversion p.23
- 6.13 Diverting calls when your line is busy (divert if busy) p.24
- 6.14 Do not disturb p.24
- 6.15 Leaving a recorded message for internal callers p.24
- 6.16 Consulting written messages p.25
- 6.17 Message notification p.25

7.

Managing your charges p.26

- 7.1 Charging your calls directly to business accounts p.26
- 7.2 Finding out the cost of an outside call made for an internal user from your terminal p.26
- 7.3 Call duration restriction p.26

8.

Programming your telephone p.27

- 8.1 Initializing your voice mailbox p.27
- 8.2 Customising your voice greeting p.27
- 8.3 Modifying your personal code p.27
- 8.4 Configuring the telephone ringer p.27
- 8.5 Adjusting screen brightness p.28
- 8.6 Selecting the welcome page p.28
- 8.7 Selecting language p.28
- 8.8 Programming direct call keys p.28
- 8.9 Programming direct call keys p.29
- 8.10 Erase a programmed key p.29
- 8.11 Programming an appointment reminder p.29
- 8.12 Identify the terminal you are on p.29
- 8.13 Broadcasting background music on your loudspeaker p.30
- 8.14 Lock / unlock your telephone p.30
- 8.15 Configuring the audio jack of your telephone p.30
- 8.16 Activating/deactivating "forced headset" mode p.30
- 8.17 Installing a Bluetooth® Wireless Technology handset (matching) p.30
- 8.18 Use of the Bluetooth® handset p.31
- 8.19 Installing a Bluetooth® Wireless Technology headset (matching) p.31
- 8.20 Using a Bluetooth® Wireless Technology headset p.31
- 8.21 Deleting an accessory (headset, handset, etc.): Bluetooth® Wireless Technology p.31

9.

ACD : Agent set/Supervisor station p.32

- 9.1 Agent set p.32
- 9.2 Open an agent session (login) p.32
- 9.3 ACD application welcome screen p.32
- 9.4 The four operating statuses of the agent set p.32
- 9.5 Changing the operating status of the set p.32
- 9.6 Modifying your personal code p.32
- 9.7 Agent set p.33
- 9.8 Close the agent session (logout) p.33
- 9.9 Supervisor station p.33
- 9.10 Supervising group mailboxes p.33

Guarantee and clauses p.34

Getting to know your telephone

Handset (possibility of a wireless handset - Bluetooth® - Alcatel-Lucent IP Touch 4068 Phone only)

Adjust the tilt of the screen

■ LED

- Flashing green: incoming call.
- Flashing orange: alarm.



■ Audio keys

- Hang-up key:** to terminate a call.
- Hands-free/Loudspeaker Key:** to make or answer a call without lifting the receiver.
 - Lit in hands-free mode or headset mode (short press).
 - Flashing in loudspeaker mode (long press).
- Intercom/Mute key:**
 - During a conversation: press this key so that your correspondent can no longer hear you.
 - Terminal idle: press this key to answer calls automatically without picking up the receiver.
- To adjust the loudspeaker or handset volume up or down**

■ Extension unit



An extension unit can be fitted to your telephone. This provides additional keys which can be configured as function keys, line keys, call keys etc.
To affix labels: push the holding strip of the unit backwards to you and lift it. Install the label under the keypad, in the housing designed for, and place the keypad back into position.

■ Display and display keys

Contains several lines and pages providing information on calls and the functions accessible via the 10 keys associated with the words on the screen.

- Transfer icon:** pressing the key next to this icon allows you to program or change the transfer function.
- Headset connected.**
- Silent mode activated.**
- Appointment programmed.**
- Telephone locked.**
- Display keys:** pressing a display key activates the function shown associated with it on the screen.

■ Navigation

- OK key:** used to validate your choices and options while programming or configuring.
- Left-right navigator:** used to move from one page to another.
- Up-down navigator:** used to scroll through the content of a page.
- Back/Exit key:** to return to previous menu (short press) or return to first screen (long press) ; during a conversation, provides access to welcome screens (Menu, Info, ...) and to return to the conversation icon screens.

■ Welcome screens

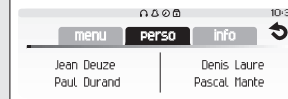

Menu page: contains all functions and applications accessible via the keys associated with the words on the screen.

Perso page: contains call line keys (allowing supervision of calls) and programmable call keys.

Info page: contains information on the telephone and the status of its functions: name, telephone number, number of messages, activation of transfer function, appointment reminder, etc.

■ Call display

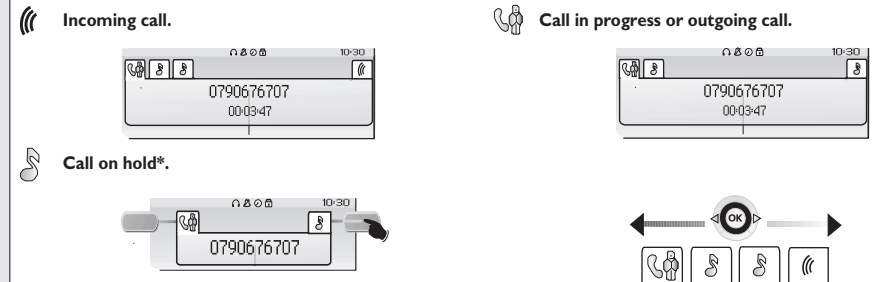

If you get two calls at the same time, you can switch from one call to the other by pressing the display key associated with each call. **Left-right navigator:** used to check calls.

■ Function keys and programmable keys

- Guide key:** used to obtain information on functions of the 'menu' page and to program key of the 'perso' page.
- Messaging key to access various mail services:**
If the key flashes, a new voice message or a new text message has been received.
- 'Redial' key:**
 - to access the 'Redial' function (short press),
 - call back on the last 10 number dialed (long press).
- Programmable key (F1 and F2 keys):**
Lit when the function associated with the key is activated.

1 Description of the screens and Bluetooth® handset

1.1 Welcome screens

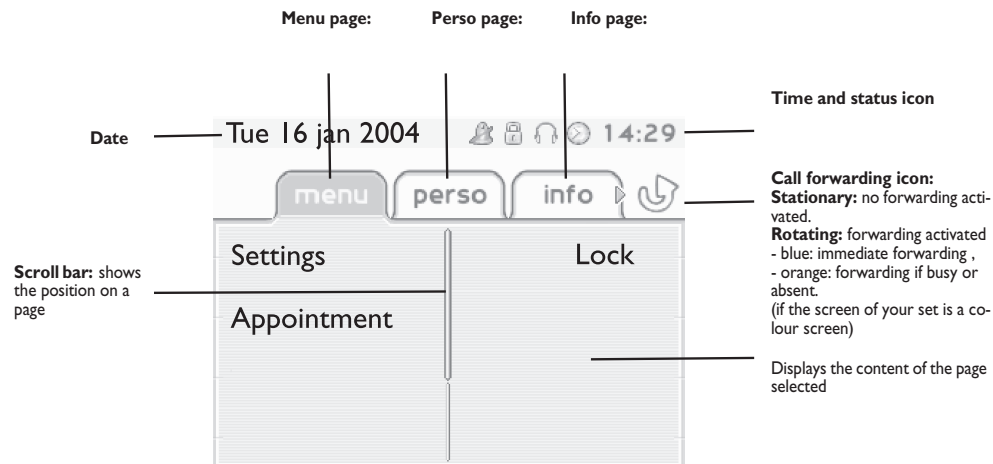

- **Menu page:** contains all functions and applications accessible via the keys associated with the words on the screen. From this page, it is possible to adjust the ringer volume and screen brightness, program the time of an appointment, lock the terminal, define the default page displayed, configure voice mail, and access telephone functions such as calling back one of the last numbers or intercepting calls.



- **Perso page:** contains call line keys (allowing supervision of calls) and programmable call keys. The up-down navigator is used to access all the direct call keys (apart from those displayed by default).



- **Info page:** contains information on the telephone and the status of its functions: name, telephone number, number of messages, activation of transfer function, appointment reminder, etc.



- **Left-right navigator:** used to move from one page to another.



- **Up-down navigator:** used to scroll through the content of a page.

Description of the screens and Bluetooth® handset

1.2 Call management screen

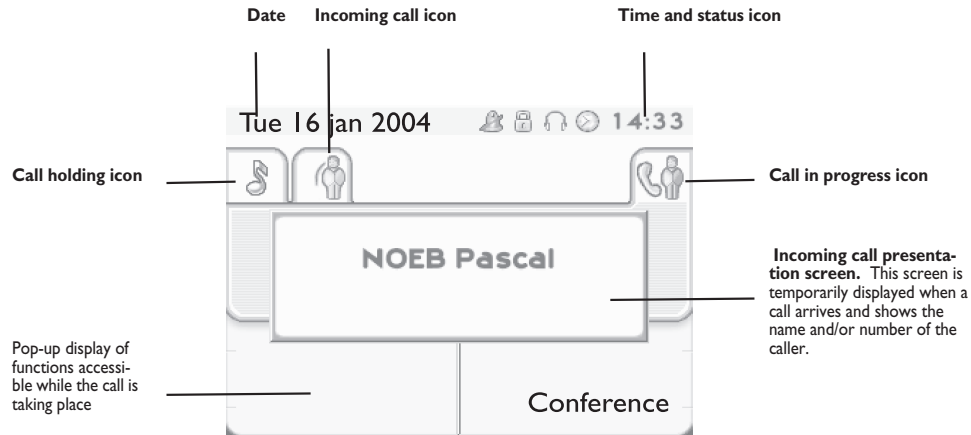

Each tab corresponds to a call, the status of which is symbolized by its icon (in progress, held, arrival of new call). When a call is in progress, use the left-right navigator to look at held or incoming calls.



Use the up-down navigator to display the functions accessible. These functions (transfer, conference, etc.) are directly related to the status of the call consulted. For example, the transfer function will not be available between a call in progress or a held call and an incoming call.



Back/Exit key: used to switch from a telephone screen to an application screen. For example, can be used while a call is in progress to look up a number, program an appointment reminder, etc.



Calls can also be managed from the Perso page. While the call is in progress, press the Back/Exit key and display the Perso page. Calls in progress or waiting are displayed on the different line keys. It is then possible to converse with the caller of your choice by pressing the key associated with him.

1.3 Application screen

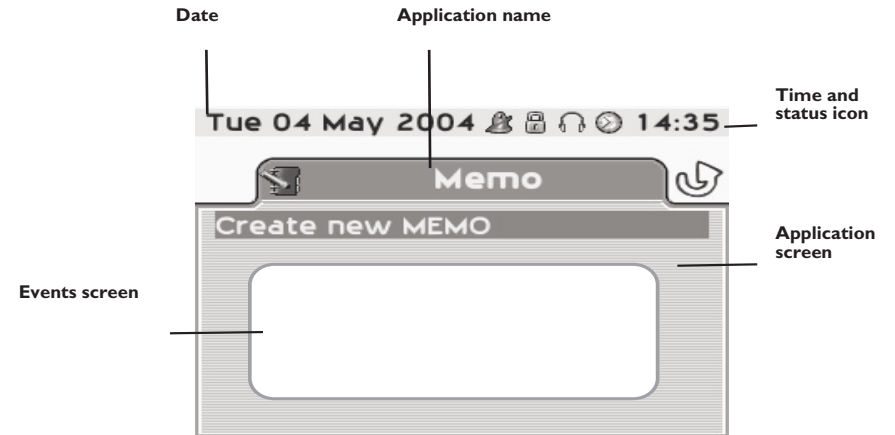

- **Application screen:** displays information relevant to programming or configuring the telephone.
- **Events screen:** displays events connected to the programming or configuration operations in progress, confirmation, rejection, error, etc.

Description of the screens and Bluetooth® handset

1.4 IP Touch Bluetooth® Wireless handset (Only available on Alcatel-Lucent IP Touch 4068 Phone set)

LED
Green flashing: normal operation.
Green steady: handset charging.
Orange flashing: battery charge low or handset outside coverage zone.
Orange steady: malfunction.

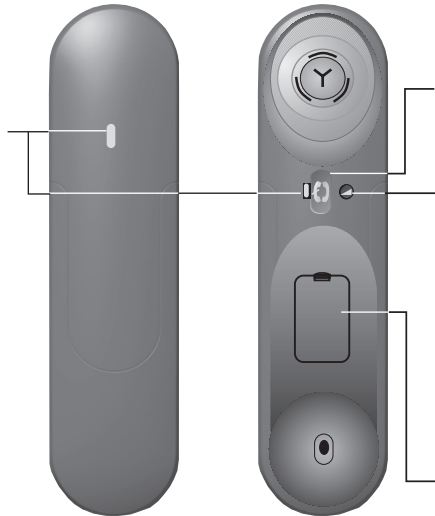

Off-hook/On-hook and Volume/Mute keys

Off-hook/On-hook: press this key to take or terminate a call

Volume/Mute:

- short successive presses to change the handset volume level (3 levels)
- long press to ensure your correspondent no longer hears you

Location of the batteries



If the Bluetooth® handset is on its base, you do not need to press the Off-hook/On-hook key to take or terminate the call. Just off-hook/on-hook the Bluetooth® handset.

• **Presentation of the battery pack:**

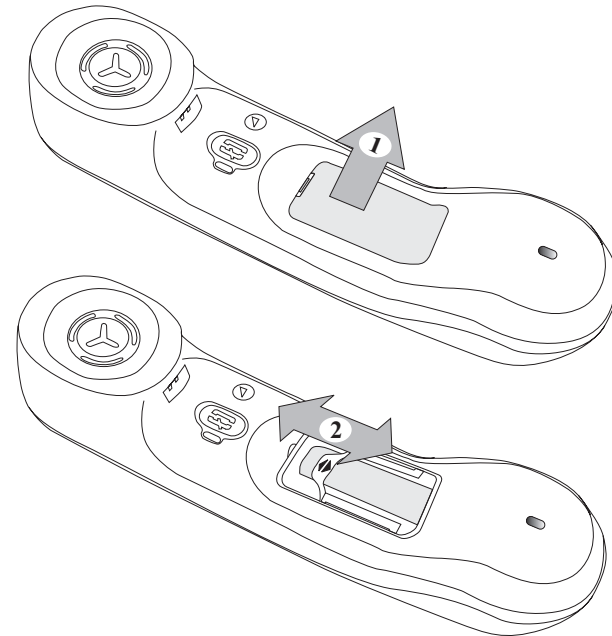

• **Installing or replacing the Bluetooth® handset battery**

①	• Lift up the battery cover
②	• Slide out the battery holding part



The battery recharges when the Bluetooth® handset is on its base.

2 Using your telephone

2.1 Making a call

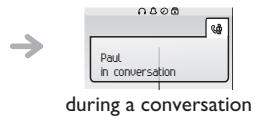
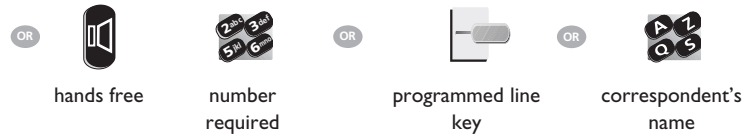
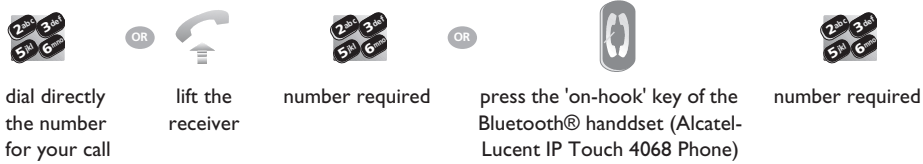

To make an external call, dial the outside line access code before dialling your correspondent's number. 9 is the default code for an outside line.

For the operator, dial '0' (by default).

The duration of your external call may be limited in time by the administrator. In this case, a beep sounds and/or a message will be displayed on the screen 20 seconds before the end of the communication

• If the internal or outside number does not reply:

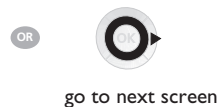
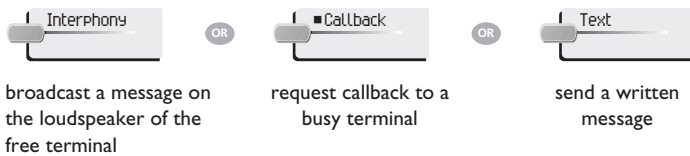

2.2 Receiving a call



The battery recharges when the Bluetooth® handset is on its base.

2.3 Using the telephone in 'Hands free' mode

■ Terminal idle:



■ Call in progress:



During a conversation, you can lift the receiver without terminating the call.

Using your telephone

2.4 Activating the loudspeaker during a conversation (receiver lifted) - Loudspeaker

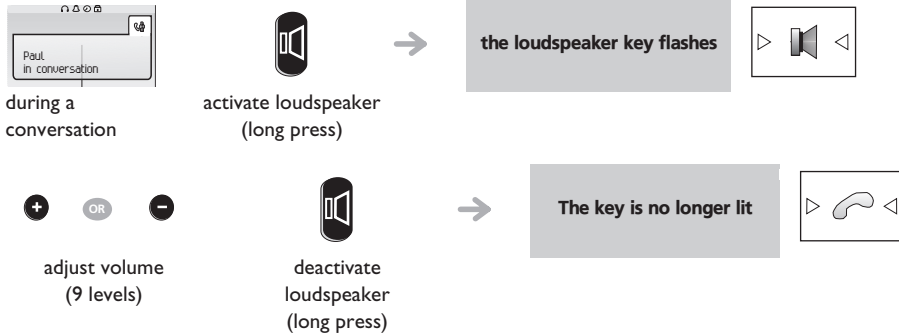

press and release the loudspeaker key to switch to hands free mode (light steady).

2.5 Calling your correspondent by name (company directory)

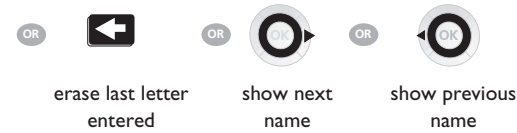
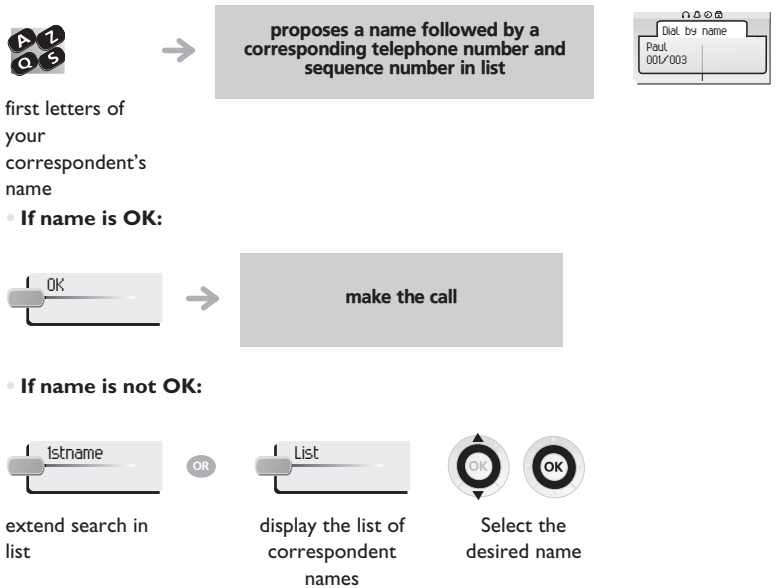

2.6 Make calls via your programmed call keys

Perso



2.7 Calling from the common directory

Your terminal has access to a common directory of outside numbers.



2.8 Filtering calls using the voice mailbox

Perso

This service lets you filter incoming calls to your voice mailbox. When your caller leaves his message you can choose to communicate with him.

• Activating call screening:

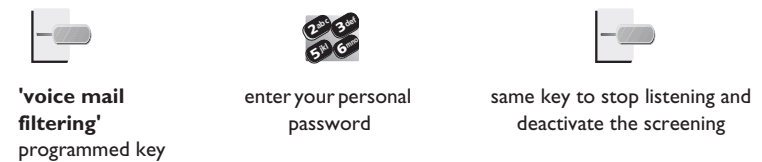

Using your telephone

When you receive a call:



2.9 Redialling

Menu

Redialling the last number dialled (redial):



Call back on the last 10 number dialled :

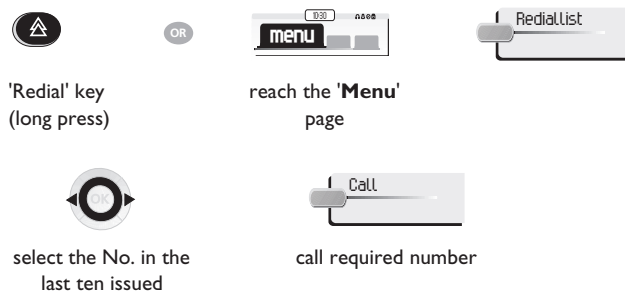

2.10 Requesting automatic callback if internal number is busy



labelling callback request:



Automatic callback is not available if the set of your correspondent is free or if you are put on hold when the set is busy.

2.11 Answering an internal call in intercom mode

You can answer without lifting the receiver. When you receive an internal call, your telephone rings and you are connected directly in hands free mode. The screen shows the caller's identity.

To activate - Terminal idle:



When your caller hangs up, intercom mode remains active.

To deactivate - Terminal idle:



2.12 Sending DTMF signals

During a conversation you sometimes have to send DTMF signals, such as with a voice server, an automated attendant or a remotely consulted answering machine.



The function is automatically cancelled when you hang up.

2.13 Mute, so that your correspondent cannot hear you

You can hear your correspondent but he/she cannot hear you:

- The terminal:

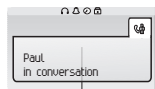

during a conversation



The key lights up

disable microphone



The key is no longer lit

resume the conversation

- The Bluetooth® receiver (Alcatel-Lucent IP Touch 4068 Phone):



press the handset volume/mute key (press and hold)

3 During a conversation

3.1 Making a second call during a conversation

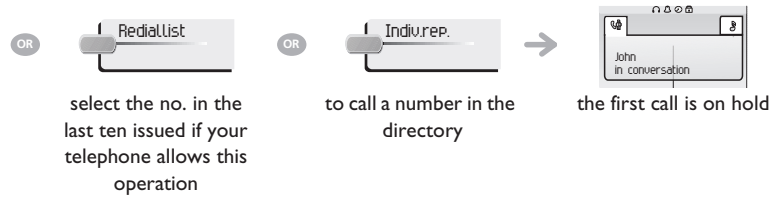
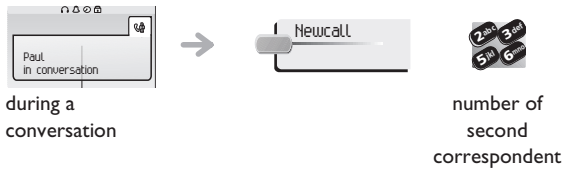

• **Other methods for calling a second correspondent:**

- Dial directly the number for your call.
- Name of second correspondent.
- To access the 'Redial' function (press and hold).
- Call back on the last 10 number dialed (short press).
- Programmed line key.

• **To cancel your second call and recover the first:**

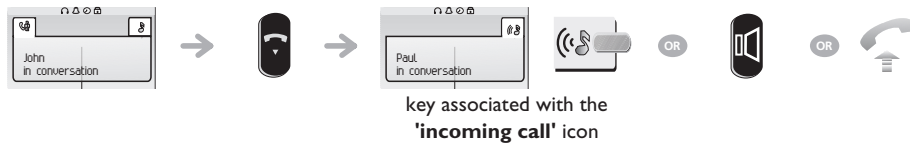

If you make an error, hang up: your telephone will ring and you will recover your first call.

3.2 Answering a second call during a conversation

• **A second correspondent is trying to call you:**

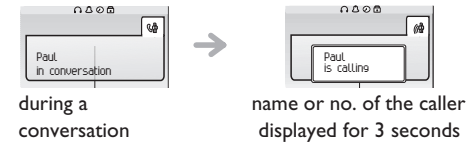

■ **Answer call displayed:**

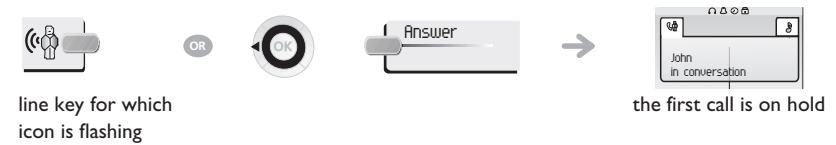

• **To return to your first caller and end the conversation in progress:**

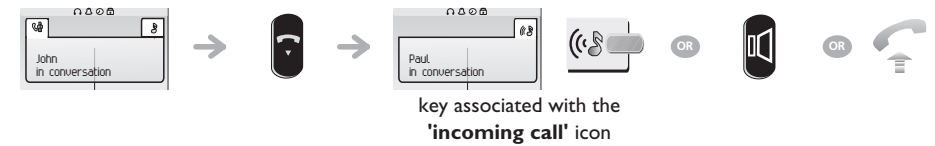

3.3 Switching between calls (Broker call)

During a conversation, a second call is on hold.
To accept the second call:

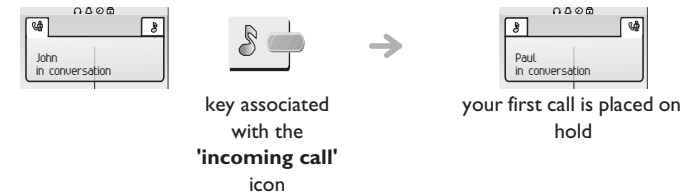

During a conversation

3.4 Transferring a call

- To transfer your call to another number:

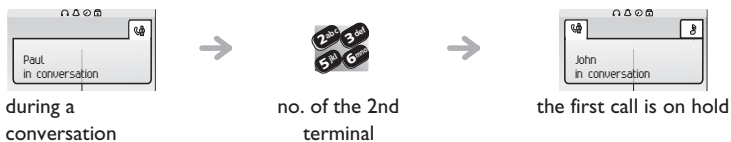

- If the number receiving the transfer answers:

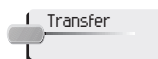

You can also transfer your call immediately, without waiting for your correspondent to answer.

Transfer between two outside calls is not generally possible (depends on country concerned and system configuration).

3.5 Transfer a call to the voice mailbox of an absent party

During the call, you want to transfer your correspondent to the voice mailbox of another correspondent.

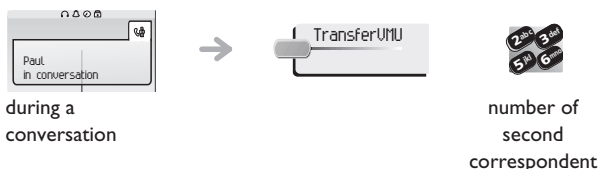

Three-way conference with internal and/or external correspondents (conference)

3.6

- During a conversation, a second call is on hold

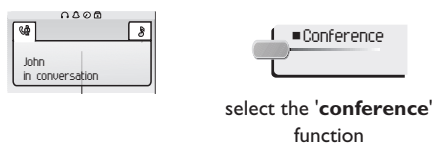

- Cancel conference and return to first correspondent (if conference is active):

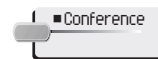

- Hang up on all correspondent (if conference is active):



- After the conference, to leave your two correspondents talking together:



cancel the conference

3.7 Placing a call on hold (hold)

- Exclusive hold:**

During a conversation, you wish to place the call on hold and recover it later, on the same telephone.



- Recover the call on hold:**



key associated with the 'incoming call' icon

- Common hold: (subject to programming)**

To recover your call on any telephone in your system.

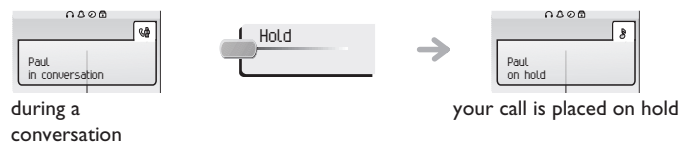

During a conversation

Recover the call on hold from any telephone:



key associated with the 'incoming call' icon

3.8 Placing an outside call on hold (parking)

You can place an outside call on hold and recover the call on another telephone:



during a conversation

• To recover the parked call:



number of telephone from which call was parked

If the parked call is not recovered within a preset time (default value 1 min 30), it is transferred to the operator.

3.9 Intrusion into an internal conversation

Your correspondent's line is busy. If the number is not "protected" and if authorised, you can intrude into the call:



same key to exit

• Protection against intrusion:



'communication protection' programmed key



enter the number



Protection is cancelled when you hang up.

3.10 Store a number

Perso

During a call, to save the number onto a call key:



during a conversation



press a call key on the Perso page



enter the name of your correspondent



apply

3.11 Adjust audio volume

During a call, to adjust the volume level of the loudspeaker or receiver:

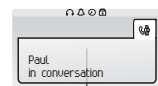

during a conversation



Adjust audio volume

4

'Meet me' conference

The 'Meet me' function is used to set up a conference with a maximum of 6 persons: the 'master' of the conference (who has the rights for initiating the conference) and the participants (maximum of 5) who meet for the conference.

4.1 Initiate a 'Meet me' conference

In order for the participants to join the conference, you must first decide on a meeting time for the conference and send them the access code.

When the system prompts you to enter a code or password, you are allowed 3 attempts before the system rejects your request.

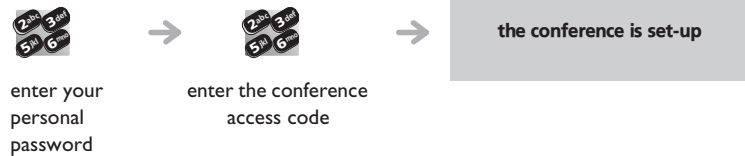
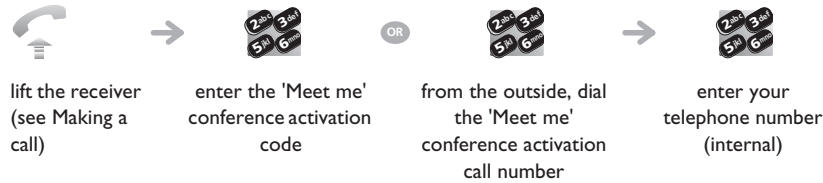

- Activation code: this code is defined by the administrator during system configuration
- Call number for activating the 'Meet me' conference: this call number is used by the conference master when he wishes to initiate a conference from an external set. This number must have been defined previously by the system administrator.
- Password: the default password cannot be used. If necessary, refer to chapter.

When the conference master on-hooks, all the communications will be cut-off.

4.2 Join a 'Meet me' conference

Once set-up by the conference master, the participants can join the 'Meet me' conference (5 participants maximum).



- Joining code: this code is defined by the administrator during system configuration
- Call number for joining the 'Meet me' conference: this call number allows the participants to join a conference from an external set. This number must have been defined previously by the system administrator.

An audible beep sounds when a participant joins the conference. 2 audible beeps sound when a participant leaves the conference.

You cannot join a conference if the maximum allowed number of participants is already reached.

If the conference has not yet been set up by the conference master you are put on hold until the conference is initiated (5 minutes maximum).

If you cannot directly reach the conference, you have to call first an internal user or an automatic operator. This one dials the call number for joining the 'Meet-me' conference and then transfers your call (10 seconds).

5.1 Receiving supervised call ringing Perso ▼

To receive the special ringing for calls to another number:



“Supervised call ringing” programmed key

same key to cancel

5.2 Answering the general bell Menu ▼

When the operator is absent, outside calls to the operator are indicated by a general bell. To answer:

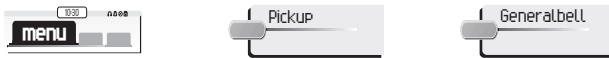

reach the 'Menu' page

5.3 Manager/secretary filtering ▼

System configuration allows “manager/secretary” groups to be formed, so that the manager’s calls can be directed to one or more secretaries.

- From the manager’s or secretary’s telephone:

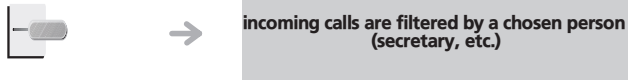

“Filter” programmed key



same key to cancel

Filtering is indicated on the manager’s telephone by the icon corresponding to the “filtering” programmed key.

5.4 Call pick-up Menu ▼

You hear a telephone ringing in an office where no-one can answer. If authorised, you can answer the call on your own telephone.

- If the telephone ringing is in your own pick-up group:



'group call pick-up' programmed key

- If the telephone ringing is not in your pick-up group:



reach the 'Menu' page

number of telephone ringing

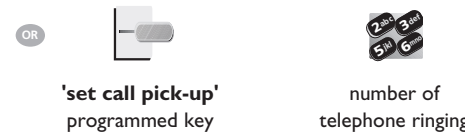

The system can be configured to prevent call pick-up on certain telephones.

5.5 Answering briefly in place of the operator ▼

Outside calls to the operator will ring on your telephone and you can answer the call:



“Operator help” programmed key

same key to cancel

- Calls to the switchboard:



“Operator help” programmed key

5.6 Hunting groups

Hunting group call:

Certain numbers can form a hunting group and can be called by dialling the group number.



no. of group to be called

Temporary exit from your hunting group:/Return into your group:



'leave group'
programmed key

your group number

Belonging to a group does not affect the management of direct calls. A specific telephone within a group can always be called by using its own number.

5.7 Calling an internal correspondent on his/her pager

The number called does not answer and you know that the person called has a pager:



your correspondent does not reply

'paging'
programmed key

paging in progress is displayed

Your correspondent can answer from any telephone in the system.

5.8 Answering a call on your pager

A call on your pager can be answered from any telephone within the system.

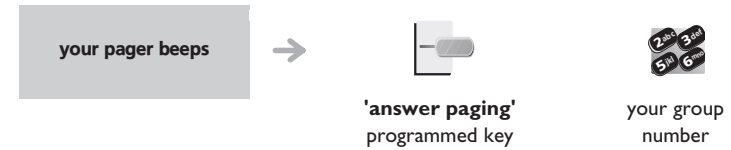

'answer paging'
programmed key

your group
number

5.9 Calling a correspondent on his/her loudspeaker

Your internal correspondent does not answer. If authorised, you can remotely activate your correspondent's phone:



your correspondent does not reply

you are connected to the loudspeaker on your correspondent's phone (if he/she has the hands free function)

5.10 Sending a written message to an internal correspondent



number to be called

enter the first letters of the name

Predefined message:

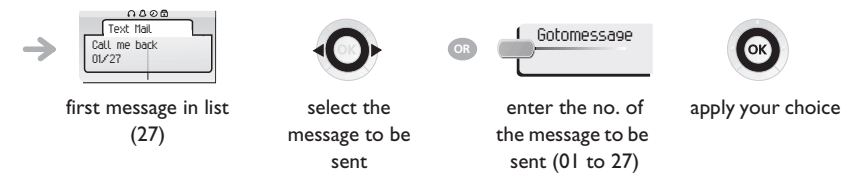

first message in list (27)

select the message to be sent

enter the no. of the message to be sent (01 to 27)

apply your choice

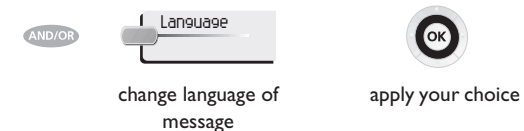

change language of message

apply your choice

Sharing

Personal message:



create a temporary personal message (alphabetic keypad)

apply your choice

The 27 standard messages are shown below:

1	Call me back	15	Meeting on ___ (*)
2	Call me back tomorrow	16	Meeting on ___ at _:_ (*)
3	Call me back at _:_ (*)	17	Out for a while
4	Call back ___ (*)	18	Absent for the rest of the day
5	Call the attendant	19	Absent, back at _:_ (*)
6	Call the secretary	20	Absent, back on ___ at _:_ (*)
7	I will call back at _:_ (*)	21	On vacation, back on ___ (*)
8	Use paging	22	External meeting
9	Please fetch your fax	23	External meeting, back on ___ (*)
10	Please fetch your mail	24	I am in room nr ___ (*)
11	Please cancel your forwarding	25	In a meeting - do not disturb
12	Visitors are waiting	26	At lunch
13	You are expected at reception	27	Indisposed
14	Meeting at _:_ (*)	(*)	Messages to be completed using numeric keypad

5.11 Send a voice message copy



personal code

display number of new and old messages

Consult



select message to copy by consecutive presses

number to be called

correspondent's name



send message

record a comment*

*To record a comment :

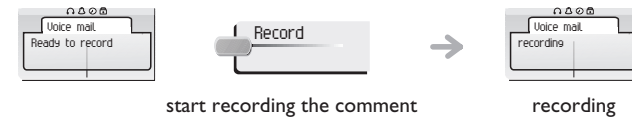

start recording the comment

recording



end of recording

replay comment



re-record a comment

send message

5.12 Sending a recorded message to a number / a distribution list



personal code

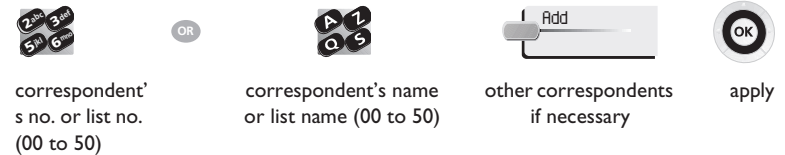

correspondent's no. or list no. (00 to 50)

correspondent's name or list name (00 to 50)

other correspondents if necessary

apply



start message recording

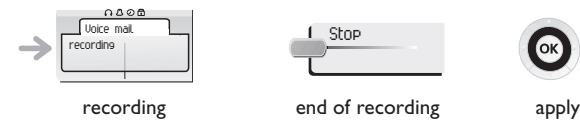

recording

end of recording

apply

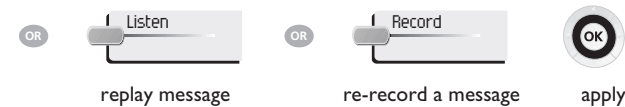

replay message

re-record a message

apply

5.13 Broadcasting a message on the loudspeakers of a station group

A message not requiring an answer can be broadcast on the loudspeakers within your broadcast group:

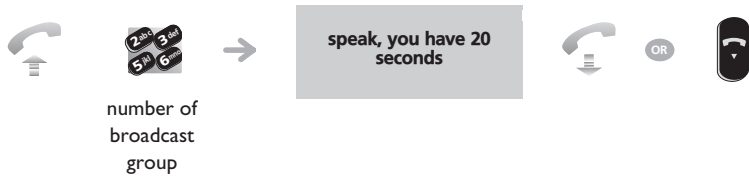

number of
broadcast
group



The message will only be broadcast on terminals not in use and which have a loudspeaker.

5.14 Modify the automated attendant welcome message remotely

This feature enables a user with the appropriate rights to modify the automated attendant night or day-time message.

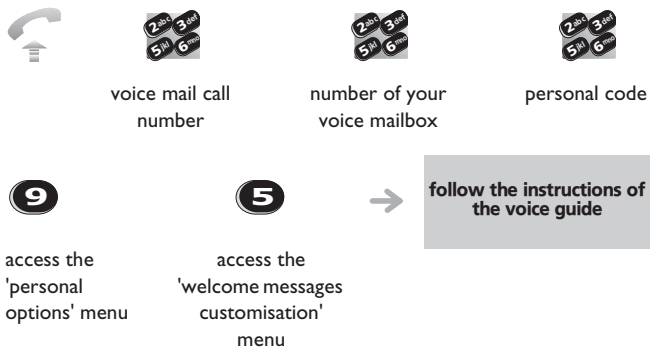

6

Keep in touch

6.1 Selecting calls to be diverted

When a diversion is applied, you can select the types of call to be diverted: outside, internal, all.

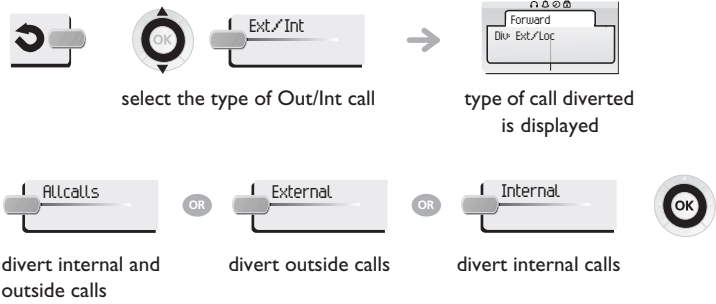

6.2 Diverting calls to another number (immediate diversion)

The number can be your home, portable or car phone, voice message or an internal extension (operator, etc.).

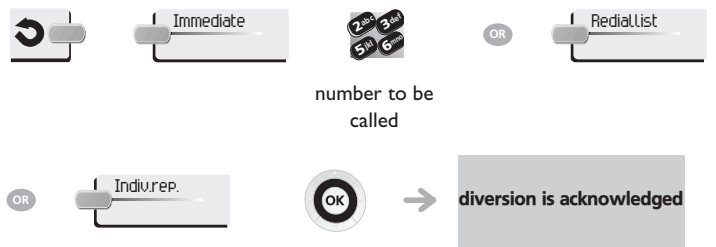

You can make calls, but only the destination number can call you.

6.3 Diverting your calls to your voice message service



6.4 When you return, consult recorded messages

The light indicates that messages have been received.

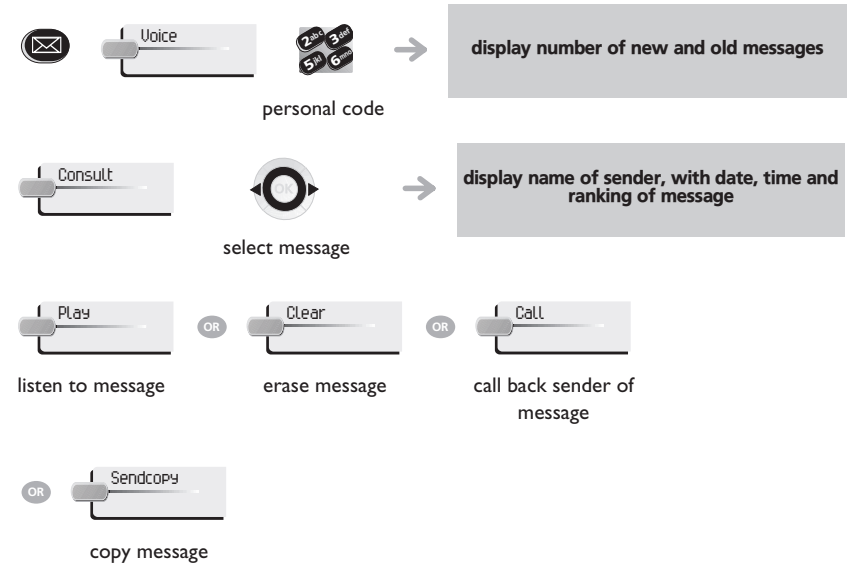

6.5 Activate/disable the personal assistant

Menu

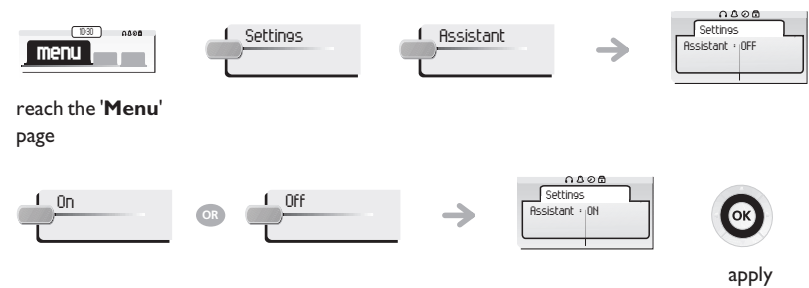

Keep in touch

6.6 Personal assistant : reaching you with one number only

Menu



reach the 'Menu' page

select type of diversion



dial number of a colleague or your secretary

dial an outside line number

dial number of your mobile or DECT



activate/deactivate transfer to operator

apply

6.7 Diverting calls to your pager

Callers will thus be able to contact you while you are moving around the company:

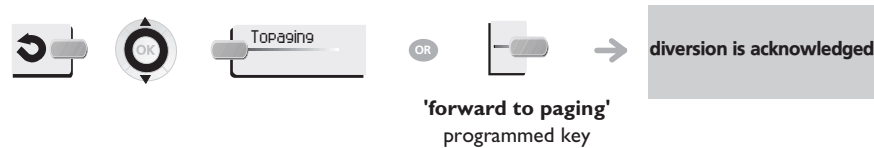

'forward to paging' programmed key

6.8 Forwarding your calls from the receiving terminal ("Follow me")

You wish to receive your calls in your present location:
Use the "Follow me" function.



your extension number



'follow-me' programmed key

your extension number

6.9 Applying a selective diversion

You can selectively divert calls, according to the caller's identity:



'selective forwarding' programmed key

6.10 Diverting all group calls

You can divert all your group calls to another internal number:



'group calls forwarding' programmed key

number receiving diversion

6.11 Cancelling all diversions



'cancel all forwarding' programmed key

programme another type of diversion

6.12 Cancelling a specific diversion



programmed key corresponding to type of diversion (group or selective)

Keep in touch

6.13 Diverting calls when your line is busy (divert if busy)

Callers can be diverted to another telephone if you are already on the line.

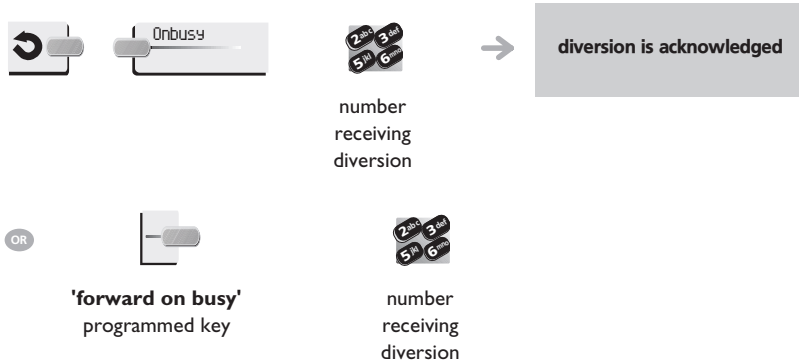

6.14 Do not disturb

You can make your terminal temporarily unavailable for all calls.

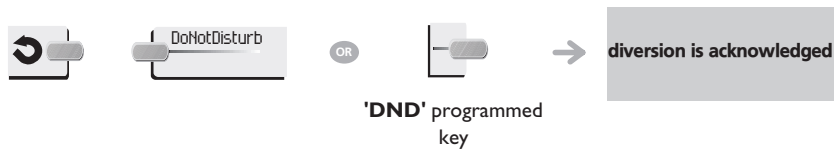

Callers wishing to contact you will see the 'Do Not Disturb' message displayed on their sets when they try to call.

6.15 Leaving a recorded message for internal callers

You can leave a message on your terminal which will be displayed on the screen of the terminal calling you.

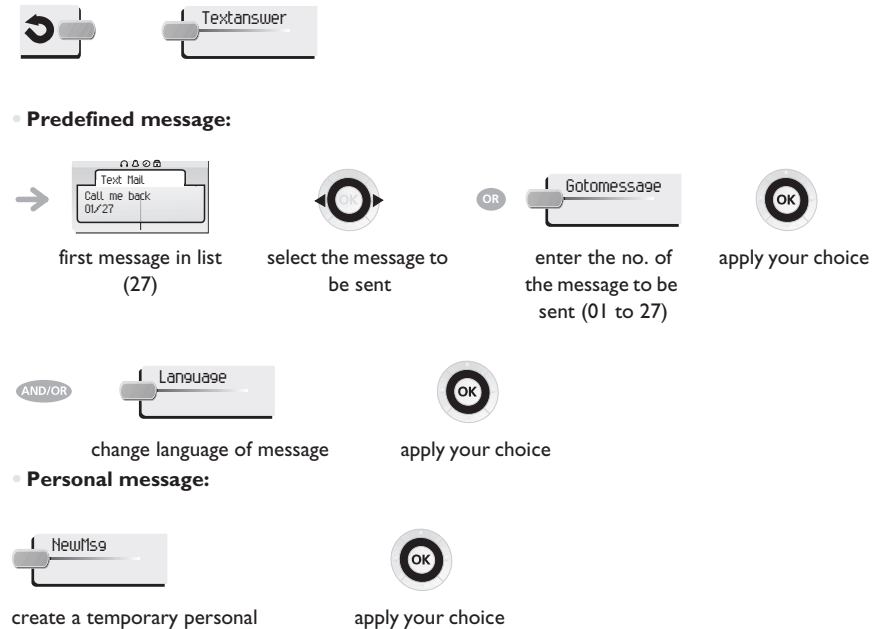

The 27 standard messages are shown below:

1	Call me back	15	Meeting on ___ (*)
2	Call me back tomorrow	16	Meeting on ___ at _: _ (*)
3	Call me back at _: _ (*)	17	Out for a while
4	Call back ___ (*)	18	Absent for the rest of the day
5	Call the attendant	19	Absent, back at _: _ (*)
6	Call the secretary	20	Absent, back on ___ at _: _ (*)
7	I will call back at _: _ (*)	21	On vacation, back on ___ (*)
8	Use paging	22	External meeting
9	Please fetch your fax	23	External meeting, back on ___ (*)
10	Please fetch your mail	24	I am in room nr ___ (*)
11	Please cancel your forwarding	25	In a meeting - do not disturb
12	Visitors are waiting	26	At lunch
13	You are expected at reception	27	Indisposed
14	Meeting at _: _ (*)	(*)	Messages to be completed using numeric keypad

Keep in touch

6.16 Consulting written messages

The light indicates that messages have been received.



Next message.



Previous message.

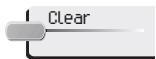

Erase message.

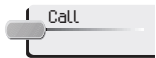

Call back sender of message.



Sending a written message to an internal correspondent.

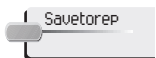

Save the sender's number in your directory.



Terminate consultation.

6.17 Message notification

Menu

A message is left in your mailbox but you are not at your desk. You can configure your telephone so that you receive notification of the message on another telephone.



reach the 'Menu' page

• **Activate/deactivate message notification:**

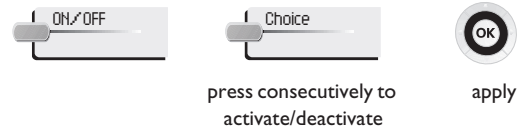

• **To pause recording:**

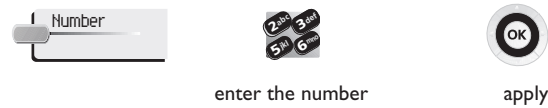

• **Change the time slot:**
the time slot during which notification is activated can be changed.



7 Managing your charges

7.1 Charging your calls directly to business accounts

You can charge the cost of your outside calls to business account numbers.

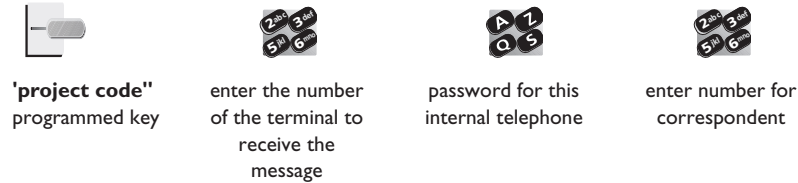

• Adding or changing a business code during a call:



7.2 Finding out the cost of an outside call made for an internal user from your terminal

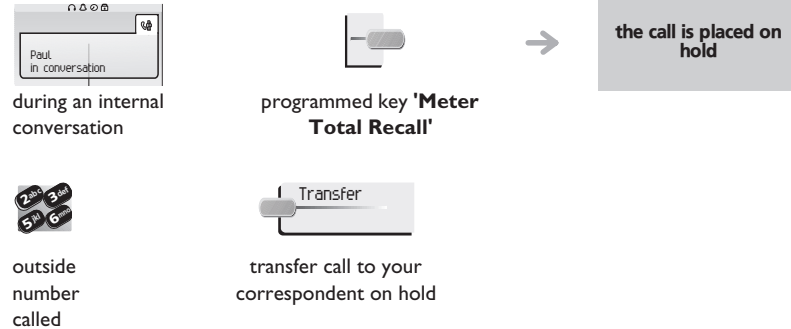

• When the internal correspondent who has taken the call on-hooks, you are called back and can:

1. Read information concerning call (cost, duration, number of units...).



2. Print a charge ticket.



3. Terminate consultation.

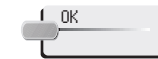

7.3 Call duration restriction

The duration of your external call may be limited in time by the administrator. In this case, a beep sounds and/or a message will be displayed on the screen 20 seconds before the end of the communication.

Call transfer : during a call transfer, the maximum duration of the call is reset to the value defined for the destination station of the transfer.

Three-party conference : during a three-party conference, communication is cut off when the maximum time allowed has expired.

'Meet me' conference : there is no call duration restriction.

Parking: the maximum duration time is not reset on parked call retrieval.

8 Programming your telephone

8.1 Initializing your voice mailbox

light flashes  enter your personal code then record your name according to voice guide instructions



 Your personal code is used to access your voice mailbox and to lock your telephone.



8.2 Customising your voice greeting

You can replace the greeting message by a personal message

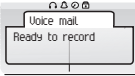
reach the 'Menu' page

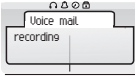
→   →  recording

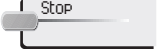
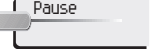
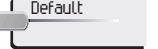
 end of recording OR  to pause recording OR  to return to the default message  apply

8.3 Modifying your personal code

Menu

Your personal code is used to access your voice mailbox and to lock your telephone.

reach the 'Menu' page

 old code (4 digits)  new code (4 digits) 

 As long as your voice mailbox has not been initialized, personal code is 1515.

8.4 Configuring the telephone ringer

Menu



   

reach the 'Menu' page

▼ Choose the tune:

  select the melody of your choice (16 tunes)  apply your choice

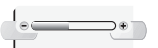
▼ Adjusting the ringer volume:

  select the volume of your choice (12 levels)  apply your choice

Programming your telephone

▼ Activate/deactivate silent mode:



▼ Activate/disable meeting mode (progressive ringing):

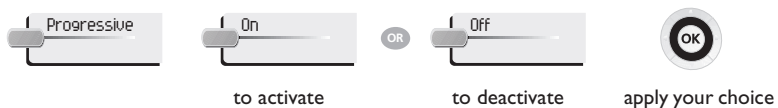

▼ Activate/deactivate discreet ring mode:

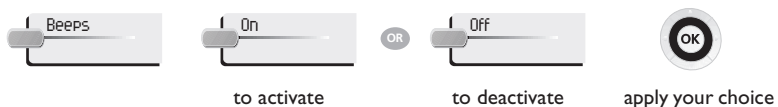

▼ Adjust ringer volume while a call arrives:



8.5 Adjusting screen brightness (Alcatel-Lucent IP Touch 4038 Phone/ 4039 Digital Phone) Menu



reach the 'Menu' page

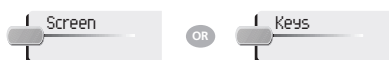

increase or reduce the brightness of the screen or keys (of the extension unit) by pressing consecutively on the corresponding keys

8.6 Selecting the welcome page Menu

This function is used to choose the page displayed by default on the telephone.

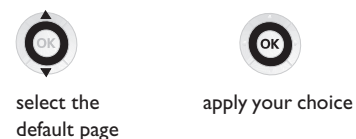

8.7 Selecting language Menu



reach the 'Menu' page



8.8 Programming direct call keys (Perso page) Perso



access the Perso page using the navigator

press a call key on the Perso page

enter the name

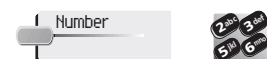

enter the number

Programming your telephone

8.9 Programming direct call keys (F1 and F2 keys)

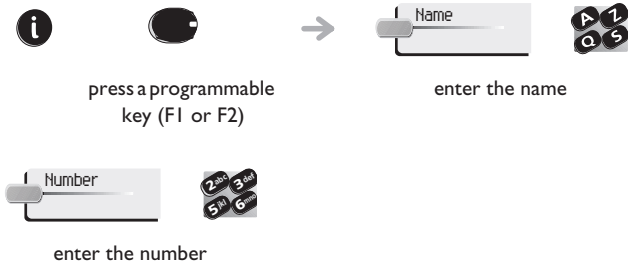

8.10 Erase a programmed key

Perso

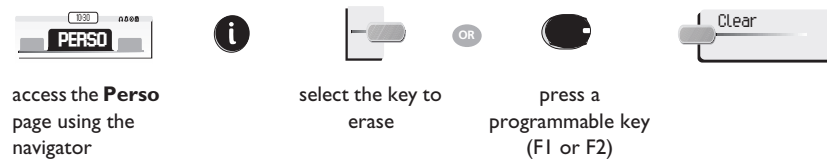

8.11 Programming an appointment reminder

Menu

You can define the time of a temporary reminder (one in 24 hours) or a permanent reminder (every day at the same time).

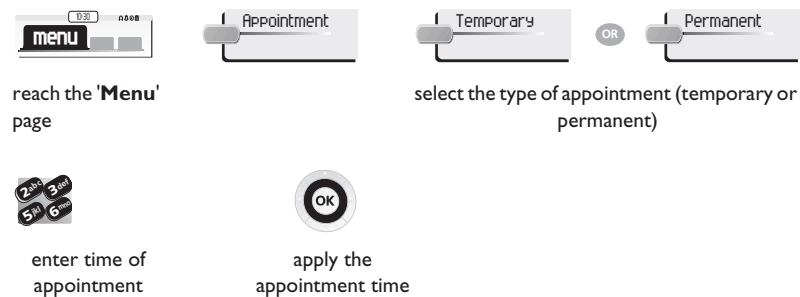

- At the programmed time, your telephone rings:



*If you are in conversation, the display flashes and an audio tone is generated. After three calls without reply, a temporary request is cancelled but a permanent request remains in memory.
If your calls are diverted to another terminal, the diversion is not applied to the reminder call.*

- To cancel your reminder request:

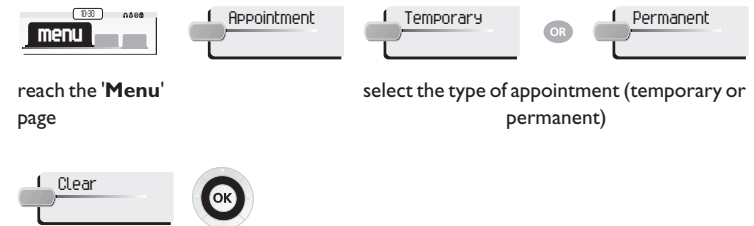

8.12 Identify the terminal you are on

Info

The number of your telephone is displayed on the 'Info' page.



Access the **Info** page using the navigator.

Programming your telephone

8.13 Broadcasting background music on your loudspeaker

You can broadcast background music on the loudspeaker of your telephone (depending on configuration):



The music stops when a call is made or received and starts again when you hang up.

8.14 Lock / unlock your telephone

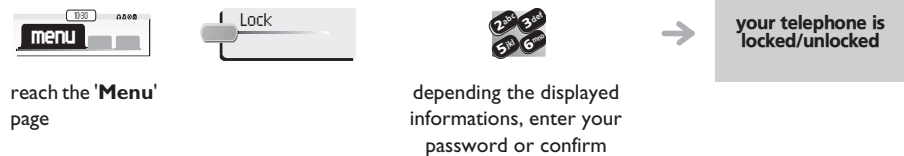

8.15 Configuring the audio jack of your telephone

By default, the audio jack of your telephone can be used to connect a headset, hands free kit or loudspeaker.

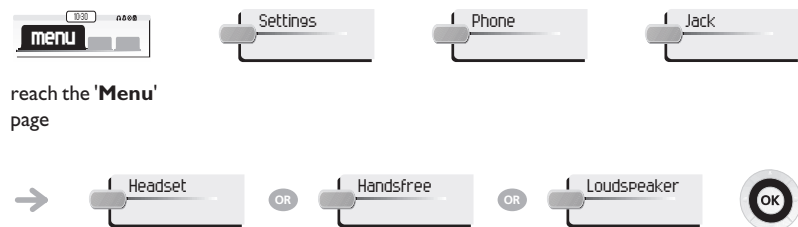

8.16 Activating/deactivating 'forced headset' mode

'Forced headset' mode must be activated as soon as a headset is installed instead of the receiver.

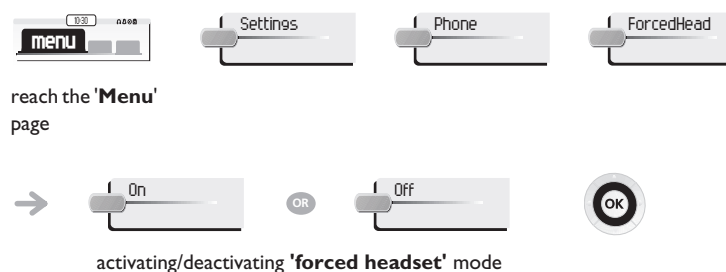

8.17 Installing a Bluetooth® Wireless Technology handset (matching) - Alcatel-Lucent IP Touch 4068 Phone

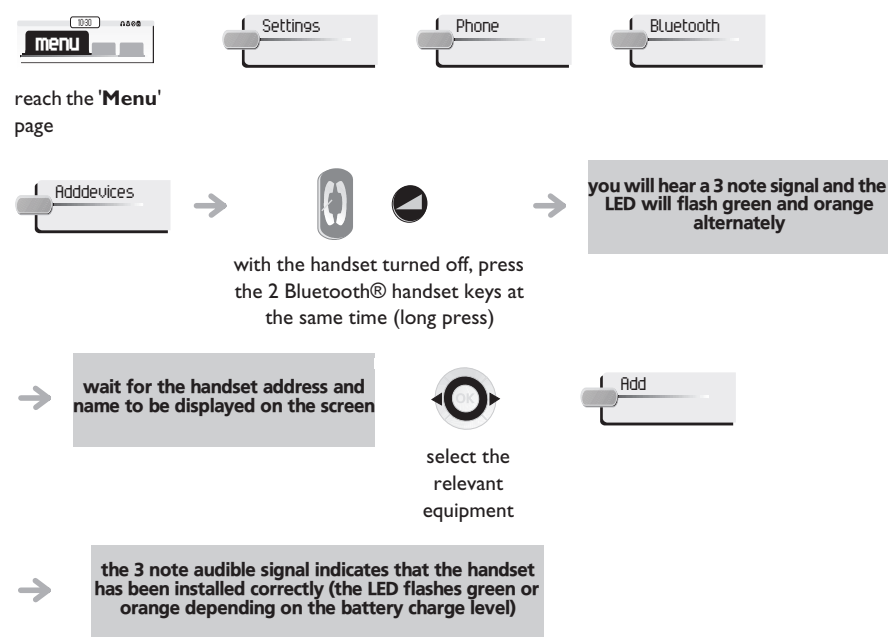

If you add the Bluetooth® handset before the name of the handset is displayed on the screen, you must enter the password 5555 to terminate the installation

Programming your telephone

Error messages

the Bluetooth® handset emits a sequence of 4 beeps	→	The generation of your station is earlier than the generation of your Bluetooth® handset
The station displays an error message indicating an incompatibility between the station and the Bluetooth® handset	→	The generation of your Bluetooth® handset is earlier than the generation of your station

8.18 Use of the Bluetooth® handset (Alcatel-Lucent IP Touch 4068 Phone)

The Bluetooth® cordless handset permits the user to answer and converse with complete freedom within a radius of 10 meter from the set.

The handset has a LED and two buttons.

Light

- **Green flashing:** normal operation.
- **Green steady:** handset charging.
- **Orange flashing:** battery charge low or handset outside coverage zone.
- **Orange steady:** malfunction.

Off-hook/On-hook and Volume/Mute keys



Off-hook/On-hook: press this key to take or terminate a call.



Volume/Mute:

- short successive presses to change the handset volume level (3 levels)
- long press to ensure your correspondent no longer hears you



If the Bluetooth® handset is on its base, you do not need to press the Off-hook/On-hook key to take or terminate the call. Just off-hook/on-hook the Bluetooth® handset.

8.19 Installing a Bluetooth® Wireless Technology headset (matching) - Alcatel-Lucent IP Touch 4068 Phone

Before a Bluetooth® headset can be used, it must be correctly matched to the terminal. Before performing the matching operation, the headset must be in detectable mode*.



reach the 'Menu' page

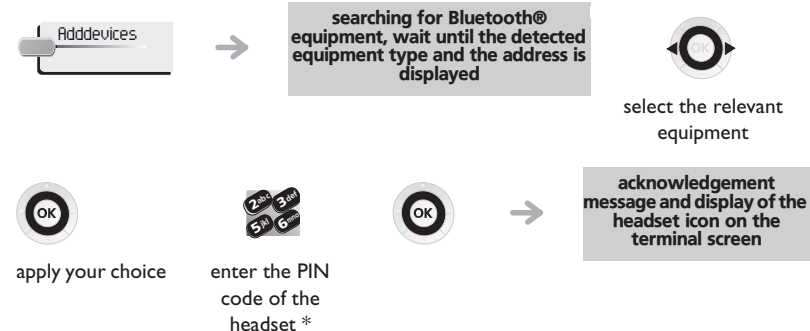
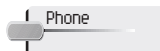
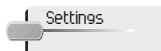

* Refer to the user documentation supplied with the headset.

8.20 Using a Bluetooth® Wireless Technology headset - Alcatel-Lucent IP Touch 4068 Phone

Refer to the user documentation supplied with the headset.

8.21 Deleting an accessory (headset, handset, etc.): Bluetooth® Wireless Technology - Alcatel-Lucent IP Touch 4068 Phone

Menu



reach the 'Menu' page



display of the different equipment matched

select the equipment to be removed

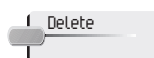

apply your choice

message acknowledging the equipment has been removed

9 ACD : Agent set/Supervisor station

9.1 Agent set

A call centre solution allows optimum distribution of calls to agents according to their availability and skills.

9.2 Open an agent session (login) - Agent set

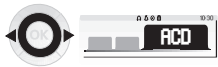

Select the ACD application



select the agent and validate



ACD application welcome screen display

depending the displayed informations, enter your password or confirm

9.3 ACD application welcome screen - Agent set

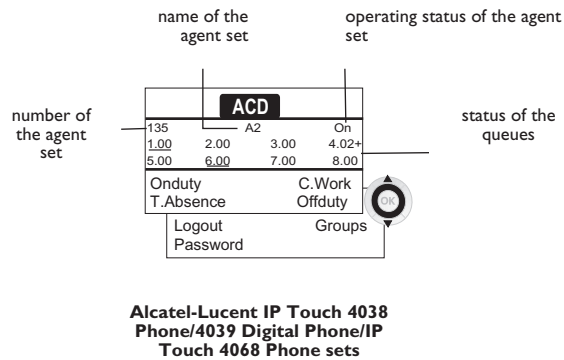

- 4.02+ means: group number 4; 2 calls waiting; the '+' sign indicates that the queue capacity has been reached (Alcatel-Lucent IP Touch 4038 Phone/4039 Digital Phone/IP Touch 4068 Phone).

9.4 The four operating statuses of the agent set

An agent's availability is determined by the operating status (of which there are 4), that the agent can change at any time. These statuses are:

- **In service:** the agent is ready to receive calls.
- **Withdrawn:** the agent has withdrawn from the ACD application.
- **Additional task:** the agent is performing a task concerning a call and is not taking other calls.
- **Temporarily absent:** the agent has taken a break and is not taking calls.

The agent can change the operating status directly by entering codes (on all sets), by pressing the function keys on the set (Alcatel-Lucent IP Touch 4028 Phone/4029 Digital Phone and Alcatel-Lucent IP Touch 4038 Phone/4039 Digital Phone/IP Touch 4068 Phone sets), or using the 'Agent Assistant' agent software on PC (if available).

9.5 Changing the operating status of the set - Agent set

Changing using codes (all sets):

the operating status change codes are defined when the system is configured. Contact the system administrator to obtain these codes.



enter the feature code to activate

Statuses	Codes
in service	
withdrawn	
additional task	
temporarily absent	



A melody is played: activation accepted, the change of status has been carried out



A 'buzzer' type alarm sounds: activation refused, the set is probably not taken into account by the call centre; you should contact your administrator

Change by function keys (Alcatel-Lucent IP Touch 4028 Phone/4029 Digital Phone and Alcatel-Lucent IP Touch 4038 Phone/4039 Digital Phone/IP Touch 4068 Phone)

Press the function key of the status to be activated. Information relative to the selected status is displayed on the screen. If a refusal message is displayed, contact the system administrator.

9.6 Modifying your personal code - Agent set

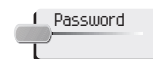

new code (4 digits)

ACD : Agent set/Supervisor station

9.7 Agent set - Integrating another group/leaving a group

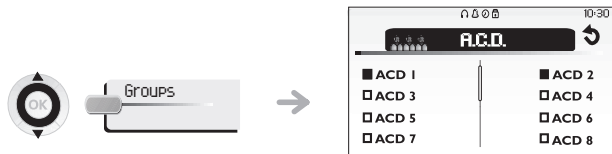

press the key of the group (1 to 8) to integrate (box empty) and/or press the key of the group to leave (box full)

9.8 Close the agent session (logout) - Agent set



9.9 Supervisor station

A supervisor can consult the messages left in the voice mailboxes of the call centre groups (maximum 8 groups) using the function keys on an Alcatel-Lucent IP Touch 4028 Phone/4029 Digital Phone or Alcatel-Lucent IP Touch 4038 Phone/4039 Digital Phone/ IP Touch 4068 Phone set.

A supervisor can also perform the agent function from the same set.

9.10 Supervising group mailboxes - Supervisor station

Consulting the messages:

When a message is left in a group mailbox, the voice mail present indicator associated with the supervision key flashes.



press the supervision key

When a mailbox is consulted by a supervisor, the other supervisors cannot access it.

Supervision keys for group mailboxes and positioning on the sets:



access the 'Perso' page

Guarantee and clauses

Independently of the legal warranty that covers this appliance, it is guaranteed for 1 year, parts and labour, counting from the date indicated on your invoice.

The invoice will be demanded if making a claim under the warranty. The warranty does not however apply in the following cases: in the event of use that does not comply with the instructions given in this user's manual, faults or damage caused by natural wear, damage resulting from a cause external to the appliance (e.g. impact, fall, exposure to dampness, etc.), noncompliant installation or modifications or repairs carried out by people who are not approved by the manufacturer or retailer.

Warning: never place your telephone in contact with water. To clean your telephone, you may however use a damp soft cloth. Never use solvents (trichlorethylene, acetone, etc.) which may damage the plastic parts of your telephone. Never spray it with cleaning products.

To avoid accidentally damaging the set telephone line connector, make sure you position the cord correctly in the compartment intended for this purpose

The ear piece and microphone area of the handset may attract metallic objects that may be dangerous for the ear.

The wording is not contractual and may be subject to change. Some functions of your telephone are controlled by a software key and the configuration of the unit.

Declaration of compliance

We, Alcatel-Lucent Enterprise, declare that the products covered by this user guide are compliant with the primary requirements of the Parliament and Council Directive 1999/5/CE. A copy of the original of this declaration of compliance can be obtained from your installer.

Consumption in standby: 3,5V.

Alcatel-Lucent IP Touch 4068 Phone & IP Touch Bluetooth® Wireless Handset

This device complies with Part 15 of the FCC Rules and with RSS-210 of Industry Canada. . Operation is subject to the following two conditions : (1) this device may not cause harmful interference, and (2) this device must accept any interference received, including interference that may cause undesired operation..

Warning : changes or modifications made to this equipment not expressly approved by Alcatel Lucent Enterprise may void the FCC authorization to operate this equipment.. This equipment has been tested and found to comply with the limits for a class B digital device, pursuant to Part 15 of the FCC Rules. These limits are designed to provide reasonable protection against harmful interference in a residential installation. This equipment generates, uses and can radiate radio frequency energy and, if not installed and used in accordance with the instructions, may cause harmful interference to radio communications. However, there is no guarantee that interference will not occur in a

particular installation. If this equipment does cause harmful interference to radio or television reception, which can be determined by turning the equipment off and on, the user is encouraged to try correct the interference by consulting the dealer..

This Class B digital apparatus complies with Canadian ICES-003.

This device has been designed and manufactured not to exceed the SAR (Specific Absorption Rate) radio frequency power transmission limits established by the different countries concerned. The SAR value measured is equal to 0.0025 W/kg (the globally accepted maximum limit being 1.6 W/kg).



Information relative to the environment

This symbol indicates that at the end of its life, this product should be subject to special collection and disposal in member countries of the European Union, as well as in Norway and Switzerland. By ensuring this product is disposed of correctly, you will help to conserve natural resources and help prevent potential negative consequences to the environment and human health which could otherwise be caused by inappropriate disposal of this product. For further details about recycling this product, please contact the supplier who sold you the product.

Operating conditions

Operating temperature range: -5°C /45°C.

Acoustic shock protection

The acoustic level of the signal generated by the handset earpiece is less than 130 dBspl for a transient signal (123 dBspl for Australia) and less than 118 dBspl (rms) for a continuous signal (120 dBA for Australia).

Directive 2003/10/EC specifying the risks inherent in noise at work

The ring contributes towards overall daily noise; at its maximum setting, the level is 105 dBA at 60 cm from terminal. To reduce the level, the following is recommended:

- reduce the setting (9 levels of 5 dB)
- program a progressive ring.

Alcatel, Lucent, Alcatel-Lucent and the Alcatel-Lucent logo are trademarks of Alcatel-Lucent. All other trademarks are the property of their respective owners. The information presented is subject to change without notice. Alcatel-Lucent assumes no responsibility for inaccuracies contained herein. Copyright © 2008 Alcatel-Lucent. All rights reserved



MU19006BSAE-O700ed01-1007